

A safe investment

An AquaGuard safety cover offers you:

Comfort

The fabric is aesthetically hidden at the border of the swimming pool and rolled up on the shaft of the mechanism.

The AquaGuard with hydraulic drive can open a cover of 10 metres within 30 seconds.



Complete safety

The fabric is led by aluminium tracks. Because the fabric is not stretched, the water can support the weight of several persons.

Electricity is kept safely away from the swimming pool.

Supports the weight of several persons

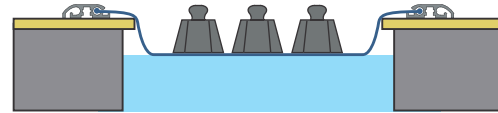

Energy saving

The cover limits evaporation and heat losses to a minimum.

Furthermore, for an indoor pool the functioning of the dehumidification system is reduced.



Less maintenance

The AquaGuard cover keeps your swimming pool clean. Dirt or leaves cannot fall into the pool and can easily be removed. Any small amount of rainwater on the cover is evacuated through a zipper in the fabric.

The rainwater pump automatically pumps away the excess water.

Use throughout all seasons

The AquaGuard can be used both in summer and winter.

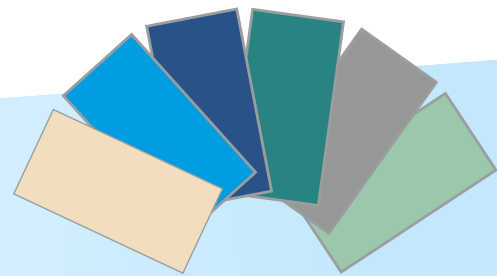

Quality!

The AquaGuard consists of:

Fabric

The AquaGuard is made of reinforced PVC fabric. Both sides of the fabric are reinforced by a welded polyester tape.

Tracks and edge

The tracks and the edge of the AquaGuard are made of 25µm anodized aluminium.

Mechanism

The shaft of the AquaGuard is made of 25µm anodized aluminium.

Automation

The manual version consists of 2 gearboxes that are driven by a crank.

Optionally, a battery-powered screwdriver can also be delivered.

The hydraulic version consists of two maintenance-free hydraulic motors that are driven by a hydraulic pump unit.

The hydraulic pump unit is housed in a technical room, at a safe distance from the pool.

The AquaGuard cover is operated by a key-switch with hold contact. The key switch is placed in a way that the swimming pool is always visible.



Guarantee:
Hydraulic pump: 2 years
Fabric: 7 years degressive
Mechanism: 10 years

In accordance with the French standard NFP 90-308



The AquaGuard covers are exclusively installed by professional dealers. They help you to find the right solution for your pool.

T&A The AquaGuard covers are made in Belgium by **Technics & Applications**.

Your dealer:

When safety is your priority!

Top-mount mechanism

The fabric is rolled up above the swimming pool.

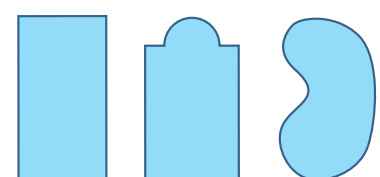

Ideal for existing swimming pools

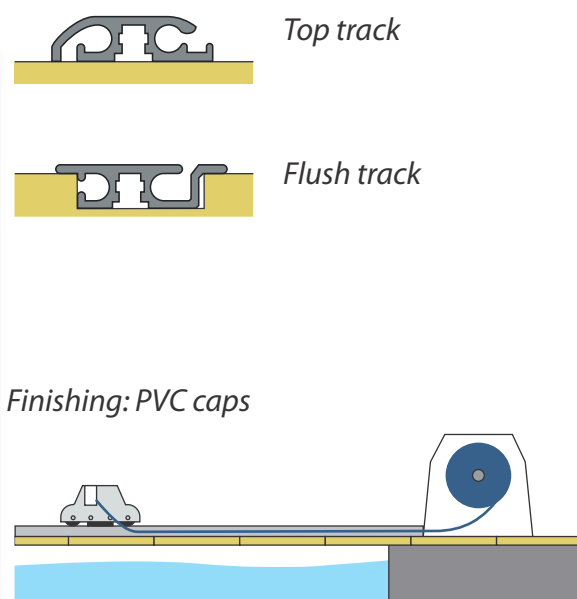

Recessed mechanism

The fabric is rolled up in a dry niche behind the swimming pool.

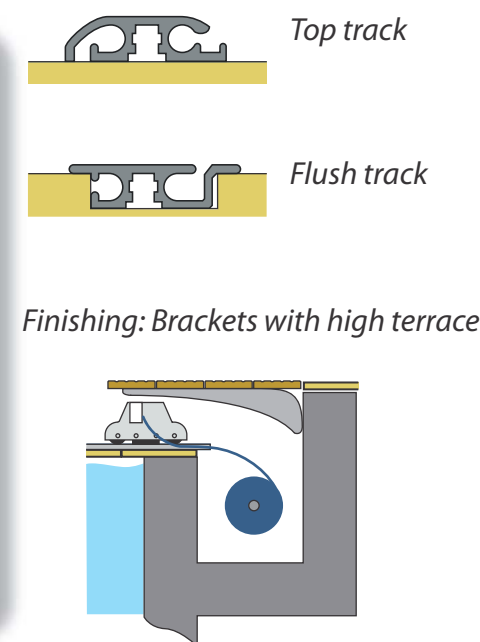
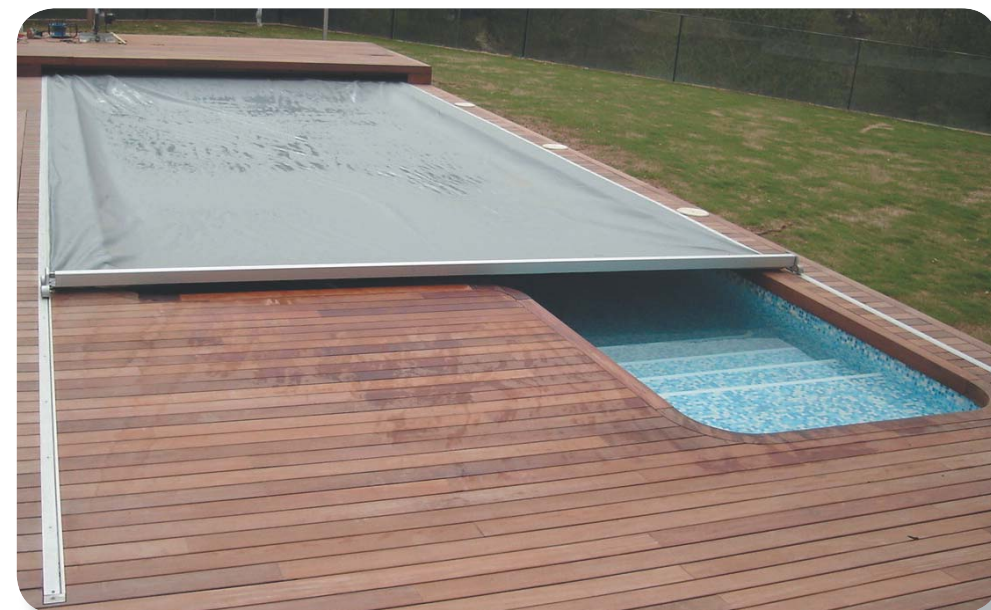
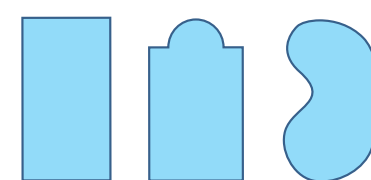

Recessed mechanism

The fabric is rolled up in a dry niche behind the swimming pool.

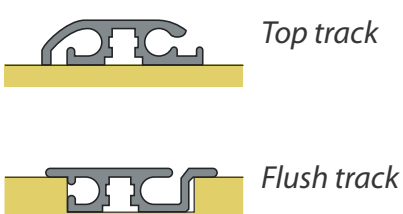
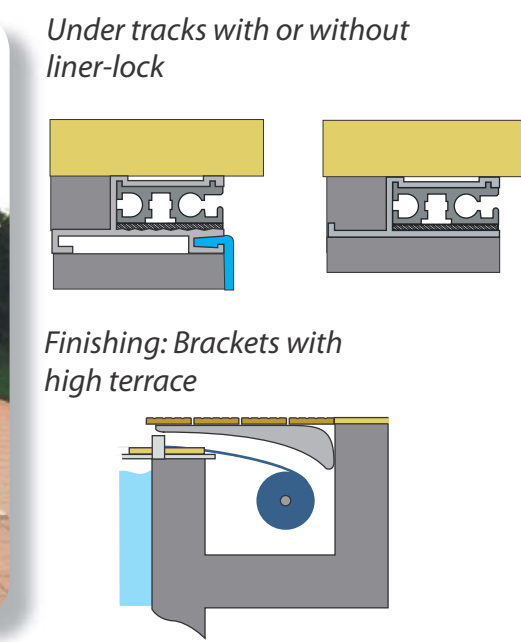
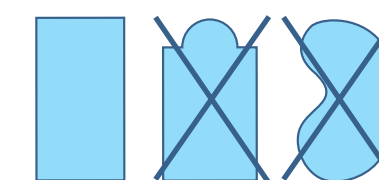

Finishing: Wooden bench

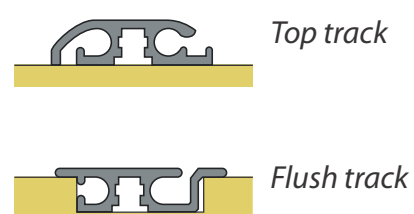
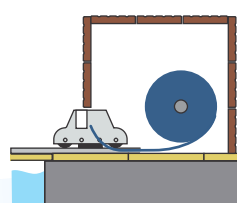

Finishing: Brackets with flat terrace

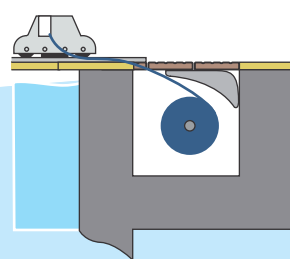

Under tracks with or without liner-lock

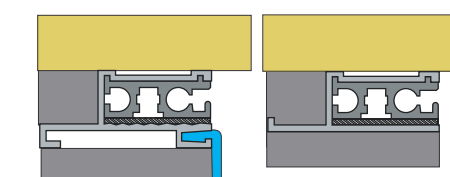

Finishing: Brackets with flat terrace

